

# TERRAIN



## Terrain HDPE

Product Guide

# Terrain HDPE



A modern high density polyethylene system with many advantages over cast iron and other traditional systems. Terrain HDPE is a top-to-bottom solution for all above ground drainage and many chemical waste applications. It allows specifiers and installers to benefit by providing them maximum flexibility in the design process.

Utilising the intrinsic properties of high-density polyethylene, Terrain HDPE offers greater benefits above and beyond more traditional materials and performs significantly better when tested for impact and abrasion resistance, chemical corrosion and extreme temperatures.

The lightweight nature of Terrain HDPE allows the product to be installed quickly and efficiently, giving direct, resource-saving benefits to specifiers and installers.

*HDPE offers exceptional performance above and beyond traditional pipe materials including:*

- Versatile application
- Highly resistant to impact even at low temperatures
- Highly resistant to chemical agents
- Corrosion resistant
- Abrasion resistant
- Lightweight and easy to install
- Ideal for pre-fabrication
- Suitable for use with Terrain HydroMax™ Siphonic System (see page 41 for further details)



## Innovative Products

Building on its reputation for innovation, Terrain has developed these problem solving products to offer unrivalled installation options

### Ventilation Branch

- Negates the need for a separate ventilation pipe
- Reduces the speed of the descending water
- 3 x 110mm and 3 x 75mm connections
- Ventilation at each branch
- Available in 110mm or 160mm
- See page 28 for further details



### Universal Soil Manifold

- For connection of 56mm waste pipes at floor level
- 4 inlets
- Compact size
- 110mm & 160mm
- 110mm available with 90° or 45° inlets
- See page 24 for further details

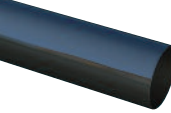

## Pipes

	Size mm	Packing Length	Pack Quantity	Code
<b>HDPE Pipe - 5 metre length</b>				
	40	550	110	900.40.50
	50	430	86	900.50.50
	56	490	98	900.56.50
	63	330	66	900.63.50
	75	290	58	900.75.50
	90	290	58	900.90.50
	110	285	57	900.110.50
	125	170	34	900.125.50
	160	50	10	900.160.50
	200	50	10	900.200.50
	250	40	8	900.250.50
	315	30	6	900.315.50

### HDPE Pipe - 3 metre length

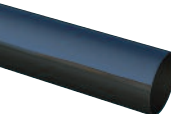
	40	150	50	900.40.30
	50	150	50	900.50.30
	56	120	40	900.56.30
	63	105	35	900.63.30
	75	90	30	900.75.30
	90	60	20	900.90.30
	110	45	15	900.110.30
	125	30	10	900.125.30
	160	30	10	900.160.30

s shown are for one item excluding VAT Note: Orders must be in pack quantity multiples

## Fittings

	Size mm	Pack Quantity	Code
<b>HDPE 90° bend</b>			
	40	50	907.40.90
	50	25	907.50.90
	56	25	907.56.90
	63	20	907.63.90
	75	25	907.75.90
	90	15	907.90.90
	110	10	907.110.90
	125	10	907.125.90
	160	1	907.160.90

### HDPE 90° wide radius bend

	200*	1	907.200.90
	250*	1	907.250.90
	315*	1	907.315.90

\*Segmented

### HDPE 91.5° (88.5°) bend

	40	50	901.40.92
	50	20	901.50.92
	56	20	901.56.92
	63	25	901.63.92
	75	20	901.75.92
	90	15	901.90.92
	110	15	901.110.92
	125	10	901.125.92
	160	1	901.160.92

## Fittings

	Size mm	Pack Quantity	Code
<b>HDPE 45° bend with socket branch</b>			
	110/40	1	901.11040.135
	90/40	1	901.9040.135
	110/50	1	901.11050.135

### HDPE 45° bend

	40	40	901.40.135
	50	30	901.50.135
	56	25	901.56.135
	63	30	901.63.135
	75	25	901.75.135
	90	20	901.90.135
	110	25	901.110.135
	125	15	901.125.135
	160	1	901.160.135
	200*	1	901.200.135
	250*	1	901.250.135
*Segmented	315*	1	901.315.135

### HDPE 180° bend

	40	40	901.40.180
	50	20	901.50.180
	56	20	901.56.180
	63	20	901.63.180
	75	10	901.75.180
	90	10	901.90.180
	110	10	901.110.180

### HDPE 90° reducing bend

	50/40	40	901.5040.90
	63/50	20	901.6350.90

### HDPE Y branch 45°

	40	50	904.40.135
	50	20	904.50.135
	56	20	904.56.135
	63	15	904.63.135
	75	20	904.75.135
	90	15	904.90.135
	110	10	904.110.135
	125	10	904.125.135
	160	1	904.160.135
	200*	1	904.200.135
	250*	1	904.250.135
*Welded	315*	1	904.315.135

### HDPE branch 90°

	40	50	904.40.90
	50	25	904.50.90
	56	25	904.56.90
	63	20	904.63.90
	75	15	904.75.90
	90	20	904.90.90
	110	15	904.110.90
	125	15	904.125.90
	160	1	904.160.90
	200*	1	904.200.90
	250*	1	904.250.90
*Welded	315*	1	904.315.90

# HDPE

## Fittings

Size mm	Pack Quantity	Code
<b>HDPE reducing Y branch 45°</b>		
 50/40	20	904.5040.135
56/50	20	904.5650.135
63/40	15	904.6340.135
63/50	15	904.9056.135
63/56	15	904.6350.135
75/40	25	904.6356.135
75/50	25	904.7540.135
75/56	25	904.9075.135
75/63	25	904.7550.135
90/40	15	904.7556.135
90/50	15	904.9040.135
90/56	20	904.7563.135
90/63	15	904.9050.135
90/75	15	904.11040.135
110/40	10	904.9063.135
110/50	10	904.11050.135
110/56	10	904.11056.135
110/63	10	904.11063.135
110/75	10	904.11075.135
110/90	10	904.11090.135
125/40	10	904.12540.135
125/50	10	904.12550.135
125/56	10	904.12556.135
125/63	10	904.12563.135
125/75	10	904.12575.135
125/90	10	904.12590.135
125/110	10	904.125110.135
160/110	1	904.160110.135
160/125	1	904.160125.135
200/110*	1	904.200110.135
200/125*	1	904.200125.135
200/160*	1	904.200160.135
250/110*	1	904.250110.135
250/125*	1	904.250125.135
250/160*	1	904.250160.135
250/200*	1	904.250200.135
315/110*	1	904.315110.135
315/125*	1	904.315125.135
315/160*	1	904.315160.135
315/200*	1	904.315200.135
315/250*	1	904.315250.135

\*Welded

### HDPE swept branch fitting

 110/110	15	904.315200.135
--	----	----------------

### HDPE 45° double reducing branch

 10/40	10	906.11040.135
10/50	10	906.11050.135
10/110	10	906.110.135

## Fittings

Size mm	Pack Quantity	Code
<b>HDPE double Y branch 60°</b>		
 50/40	25	906.5040.60
53/50	25	906.6350.60
110/110	10	906.110.60

### HDPE reducing branch 90°





 50/40	25	904.5040.90
56/50	25	904.5650.90
63/40	20	904.6340.90
63/50	20	904.6350.90
63/56	20	904.6356.90
75/40	25	904.7540.90
75/50	20	904.7550.90
75/56	20	904.7556.90
75/63	20	904.7563.90
90/40	20	904.9040.90
90/50	20	904.9050.90
90/56	20	904.9056.90
90/63	20	904.9063.90
90/75	20	904.9075.90
110/40	15	904.11040.90
110/50	15	904.11050.90
110/56	15	904.11056.90
110/63	15	904.11063.90
110/75	15	904.11075.90
110/90	15	904.11090.90
125/110	15	904.125110.90
160/110	1	904.160110.90
160/125	1	904.160125.90
200/110*	1	904.200110.90
200/125*	1	904.200125.90
200/160*	1	904.200160.90
250/110*	1	904.250110.90
250/125*	1	904.250125.90
250/160*	1	904.250160.90
250/200*	1	904.250200.90
315/110*	1	904.315110.90
315/125*	1	904.315125.90
315/160*	1	904.315160.90
315/200*	1	904.315200.90
315/250*	1	904.315250.90

\*Welded





### HDPE 180° double branch ball fitting

 110/50	5	916.11050.180
110/56	5	916.11056.180
110/75	5	916.11075.180
110/90	5	916.11090.180
110/110	5	916.110.180
125/50	5	916.12550.180
125/56	5	916.12556.180
125/75	5	916.12575.180
125/90	5	916.12590.180
125/110	5	916.125110.180
125/125	5	916.125.180

## Fittings







	Size mm	Pack Quantity	Code
<b>HDPE 90° double branch ball fitting</b>			
	110/50	5	916.11050.90
	110/56	5	916.11056.90
	110/75	5	916.11075.90
	110/90	5	916.11090.90
	110/110	5	916.110.90
	125/50	5	916.12550.90
	125/56	5	916.12556.90
	125/75	5	916.12575.90
	125/90	5	916.12590.90
	125/110	5	916.125110.90
	125/90	5	916.12590.90
	125/125	5	916.125.90
	<b>HDPE 135° double branch ball fitting</b>		
	110/50	5	916.11050.135
	110/56	5	916.11056.135
	110/75	5	916.11075.135
	110/90	5	916.11090.135
	110/110	5	916.110.135
	125/50	5	916.12550.135
	125/56	5	916.12556.135
	125/75	5	916.12575.135
	125/90	5	916.12590.135
	125/110	5	916.125110.135
	125/125	5	916.125.135
<b>HDPE 90° multi branch ball fitting</b>			
	110/50	5	916.11050.903
	110/56	5	916.11056.903
	110/75	5	916.11075.903
	110/90	5	916.11090.903
	110/110	5	916.110.903
	125/50	5	916.12550.903
	125/56	5	916.12556.903
	125/75	5	916.12575.903
	125/90	5	916.12590.903
	125/110	5	916.125110.903
	125/125	5	916.125.903
<b>HDPE 135° multi branch ball fitting</b>			
	110/50	5	916.11050.1353
	110/56	5	916.11056.1353
	110/75	5	916.11075.1353
	110/90	5	916.11090.1353
	110/110	5	916.110.1353
	125/50	5	916.12550.1353
	125/56	5	916.12556.1353
	125/75	5	916.12575.1353
	125/90	5	916.12590.1353
	125/110	5	916.125110.1353
	<b>HDPE 90° multi branch ball fitting</b>		
	110/50	5	916.11050.904
	110/56	5	916.11056.904
	110/75	5	916.11075.904
	110/90	5	916.11090.904
	110/110	5	916.110.904
	125/50	5	916.12550.904
	125/56	5	916.12556.904
	125/75	5	916.12575.904
	125/90	5	916.12590.904
	125/110	5	916.125110.904
	125/125	5	916.125.904

## Fittings







	Size mm	Pack Quantity	Code	
<b>HDPE universal soil manifold</b>				
	For connections of 56mm waste pipes at floor level. Incorporates 4 inlets to accept 56mm waste pipes.			
	60	45° inlets	1	919.160.56
	110	45° inlets	1	919.110.56A
	110	90° inlets	1	919.110.56AB
<b>HDPE short ring seal socket</b>				
	90/90	25	909.90	
	110/110	25	909.110	
<b>HDPE ring seal adaptors with cap</b>				
	40	40	927.40	
	50	30	927.50	
	56	30	927.56	
	63	20	927.63	
	75	20	927.75	
	90	25	927.90	
	110	10	927.110	
	125	10	927.125	
	160	1	927.160	
	200	1	927.200	
	250	1	927.250	
315	1	927.315		
<b>HDPE expansion joint with cap</b>				
	40	20	911.40	
	50	15	911.50	
	56	15	911.56	
	63	15	911.63	
	75	10	911.75	
	90	15	911.90	
	110†	10	911.110	
	125	10	911.125	
	160	1	911.160	
	200	1	911.200	
	250*	1	911.250	
	315*	1	911.315	
	†For Rigid pipe support *without cap			
<b>HDPE spigot bend with cap</b>				
	40/46	40	917.4046.90	
	50/46	40	917.5046.90	
	50/58	20	917.5058.90	
	56/46	20	917.5646.90	
	56/58	20	917.5658.90	
<b>HDPE extended spigot bend</b>				
	5	20	902.56.90	
<b>HDPE sleeve</b>				
	40/46	40	917.4046	
	50/46	40	917.5046	
	50/58	20	917.5058	
	56/46	20	917.5646	
	56/58	20	917.5658	

# HDPE





## Fittings

	Size mm	Pack Quantity	Code
<b>HDPE gasket</b>			
	46/36-40	100	917.4636.908
	58/36-40	100	917.5836.908
	58/47-50	100	917.5847.908
<b>HDPE concentric reducer</b>			
	50/40	50	924.5040
	56/50	50	924.5650
	63/40	40	924.6340
	63/50	40	924.6350
	63/56	40	924.6356
	75/40	40	924.7540
	75/50	30	924.7550
	75/56	30	924.7556
	75/63	30	924.7563
	90/40	20	924.9040
	90/50	20	924.9050
<b>HDPE concentric reducer</b>			
	90/56	20	924.9056
	90/63	20	924.9063
	90/75	20	924.9075
	110/40	25	924.11040
	110/50	25	924.11050
	110/56	25	924.11056
	110/63	25	924.11063
	110/75	20	924.11075
	110/90	20	924.11090
	125/50	20	924.12550
	125/56	20	924.12556
	125/63	20	924.12563
	125/75	20	924.12575
	125/90	20	924.12590
	125/110	20	924.125110
	160/110	1	924.160110
	200/160	1	924.200160
<b>HDPE threaded coupling</b>			
	50	30	912.50
	56	20	912.56
	56/63	20	912.63
	63	20	912.5663
	75	20	912.75
	90	15	912.90
	110	10	912.110
<b>HDPE ring</b>			
	50	10	9118.50
	56	10	9118.56
	63	10	9118.63
	75	10	9118.75
	90	10	9118.90
	110	10	9118.110
<b>HDPE ring seal</b>			
	50	1	9119.50
	56	1	9119.56
	63	1	9119.63
	75	1	9119.75
	90	1	9119.90
	110a	1	9119.110
	110b	1	9119.110B



## Fittings

	Size mm	Pack Quantity	Code
<b>HDPE nut</b>			
	50	10	9120.50
	56	10	9120.56
	63	10	9120.63
	75	10	9120.75
	110	10	9120.110
<b>HDPE screwed end cap</b>			
	40		936.40
	50	30	936.50
	56	20	936.56
	63	20	936.63
	75	20	936.75
	90	15	936.90
	110	15	936.110
<b>HDPE short end cap with seal</b>			
	110	10	9938.110
<b>HDPE threaded union</b>			
	50	10	9122.50
	56	10	9122.56
	63	10	9122.63
	75	10	9122.75
	90	10	9122.90
	110	10	9122.110
<b>HDPE end cap with seal</b>			
	50	10	9121.50
	56	10	9121.56
	63	10	9121.63
	75	10	9121.75
	90	10	9121.90
	110	10	9121.110
<b>HDPE blank end</b>			
	40	100	930.40
	50	100	930.50
	56	100	930.56
	63	50	930.63
	75	30	930.75
	90	30	930.90
	110	30	930.110
	125	20	930.125
<b>HDPE end cap</b>			
	160	1	930.160
	200	1	930.200
	250	1	930.250
	315	1	930.315

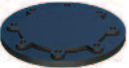





## Fittings



	Size mm	Pack Quantity	Code
<b>HDPE anchor pipe</b>			
	50	40	970.50
	56	20	970.56
	63	20	970.63
	75	20	970.75
	90	15	970.90
	110	10	970.110
<b>HDPE galvanised bolt with washer for flange</b>			
	M16x90 (50-56 flange)	1(4pcs)	984.1650
	M16x100 (63-75 flange)	1(4pcs)	984.1663
	M16x100 (90 flange)	1(8pcs)	984.1690
	M16x110 (110-140 flange)	1(8pcs)	984.16110
	M20x110 (160 flange)	1(8pcs)	984.20160
	M20x130 (200-315 flange)	1(12pcs)	984.20250
<b>Rubber flange seal</b>			
	50	1	982.50
	56	1	982.56
	63	1	982.63
	75	1	982.75
	90	1	982.90
	110	1	982.110
	125	1	982.125
	160	1	982.160
	200	1	982.200
	250	1	982.250
	315	1	982.315
	<b>Painted aluminium backing flange</b>		
	50	1	981.50
	56	1	981.56
	63	1	981.63
	75	1	981.75
	90	1	981.90
	110	1	981.110
	125	1	981.125
	160	1	981.160
	200	1	981.200
	250	1	981.250
	315	1	981.315
	<b>Painted aluminium blank flange</b>		
	50	1	983.50
	56	1	983.56
	63	1	983.63
	75	1	983.75
	90	1	983.90
	110	1	983.110
	125	1	983.125
	160	1	983.160
	200	1	983.200
	250	1	983.250
	315	1	983.315

## Fittings

	Size mm	Pack Quantity	Code	
<b>HDPE flange adaptors</b>				
	50	1	980.50	
	56	1	980.56	
	63	1	980.63	
	75	1	980.75	
	90	1	980.90	
	110	1	980.110	
	125	1	980.125	
	160	1	980.160	
	200	1	980.200	
	250	1	980.250	
	315	1	980.315	
	<b>HDPE 90° access pipe with screw cap</b>			
	50	1	938.50.90	
	56	1	938.56.90	
	63	1	938.63.90	
	75	1	938.75.90	
	<b>HDPE 90° access pipe with screw cap</b>			
	90	1	938.90.90	
	110	1	938.110.90	
	125	1	938.125.90	
	160	1	938.160.90	
	200	1	938.200.90	
	250	1	938.250.90	
	315	1	938.315.90	
<b>HDPE 45° access pipe with screw cap</b>				
	110/110	1	938.110.135	
	125/110	1	938.125.135	
	160/110	1	938.160.135	
<b>HDPE electrofusion couplings</b>				
	40	10	910.40	
	50	10	910.50	
	56	10	910.56	
	63	10	910.63	
	75	10	910.75	
	90	10	910.90	
	110	10	910.110	
	125	5	910.125	
	160	5	910.160	
	200	1	910.200	
	250	1	910.250	
	315	1	910.315	
	<b>HDPE male PVC adaptor with ring seal</b>			
		110/100	10	9113.110100
	<b>HDPE WC pan connector with cap</b>			
	90	20	925.90	
	110	20	925.110	

# HDPE

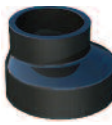
Fittings			
	Size mm	Pack Quantity	Code
<b>HDPE male PVC adaptor</b>			
	90/100	15	9113.80100
<b>HDPE female PVC adaptor with ring seal</b>			
	90/100	10	925.90100
	110/100	10	925.110100
<b>HDPE WC connector for PVC with ring seal</b>			
	100	10	925.100
<b>HDPE extended WC pan connector with cap</b>			
	90	20	993.90
	100	20	993.90
<b>HDPE sliding connector</b>			
	160	1	911s.160
	200	1	911s.200
	250	1	911s.250
	315	1	911s.315
<b>HDPE ring seal socket</b>			
	160	1	910p.160
	200	1	910p.200
	250	1	910p.250
	315	1	910p.315
<b>HDPE extended floor pan connector with 2 seals</b>			
	110	10	993.110D

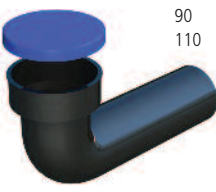
Fittings			
	Size mm	Pack Quantity	Code
<b>HDPE eccentric reducer</b>			
	50/40	50	923.5040
	56/50	30	923.5650
	63/40	30	923.6340
	63/50	30	923.6350
	63/56	30	923.6356
	75/40	30	923.7540
	75/50	30	923.7550
	75/56	30	923.7556
	75/63	30	923.7563
	90/40	20	923.9040
	90/50	20	923.9050
	90/56	20	923.9056
	90/63	20	923.9063
	90/75	20	923.9075
	110/40	20	923.11040
	110/50	20	923.11050
	110/56	20	923.11056
	110/63	20	923.11063
	110/75	20	923.11075
	110/90	20	923.11090
	125/50	10	923.12550
125/56	10	923.12556	
125/63	10	923.12563	
125/75	10	923.12575	
125/90	10	923.12590	
125/110	10	923.125110	
160/110	5	923.160110	
160/125	5	923.160125	
<b>HDPE long eccentric reducer</b>			
	160/110	5	923.160110L
	160/125	5	923.160125L
	200/110	1	923.200110L
	200/125	1	923.200125L
	200/160	1	923.200160L
	250/200	1	923.250200L
	315/200	1	923.315200L
	315/250	1	923.315250L
	<b>HDPE short radius bend</b>		
	90	10	902.90.90
	110	10	902.110.90
<b>HDPE WC bend with cap</b>			
	90	10	929.90.90
	110	10	929.110.90

## Fittings

	Size mm	Pack Quantity	Code
<b>HDPE WC bend for hanging pan with seal and cap</b>			
	90/90	10	999.90.90
	110/110	10	999.110.90
<b>HDPE WC pan connector - white</b>			
	90	10	925.90w
	110	10	925.110w
<b>HDPE straight WC pan connector with seal and cap</b>			
	90/100	10	999.90100.00
	90/100	10	998.90100.00
<b>HDPE long WC pan connector with seal</b>			
	90 (length 200mm)	10	925L.90
	90 (length 300mm)	10	925XL.90
<b>HDPE connector for wall hung pan with seal &amp; white covering</b>			
	90/44	10	925.9044
	110/44	10	925.11044
<b>HDPE WC connector for wall hung pan with seal &amp; white covering</b>			
	90	10	925.90
	110	10	925.110

## Fittings

	Size mm	Pack Quantity	Code
<b>HDPE double WC pan connector with 1 lip seals and caps</b>			
	90/110	5	929.90110.90D
	110/110	5	929.110.90D
<b>HDPE bend for wall hung pan with 1 lip seal and cap, left</b>			
	110/110	5	949.110L
	90/90	5	949.90L
	110/90	5	949.11090L
<b>HDPE bend for wall hung pan with 1 lip seal and cap, right</b>			
	110/110	5	949.110R
	90/90	5	949.90R
	110/90	5	949.11090R
<b>HDPE WC pan connectors</b>			
	110/110	5	949.110D
	110/90	5	949.11090D
<b>HDPE trap with seal and cap</b>			
	110	5	9631.110.0
	110 (45° tail)	5	9631.110.45
	110 (90° tail)	5	9631.110.90
<b>HDPE ventilation branch</b>			
	10	1	908.110
	60	1	908.160

# HDPE

## Fittings

Size mm	Pack Quantity	Code
<b>HDPE adaptor - cast iron, steel, asbestos cement pipes</b>		
 50/60	15	926.5060
50/73	15	926.5073
50/80	15	926.5080
50/90	15	926.5090
50/100	15	926.50100
56/60	15	926.5660
56/73	15	926.5673
56/80	15	926.5680
56/90	15	926.5690
56/100	15	926.56100
53/73	15	926.6373
53/80	15	926.6380
53/90	15	926.6390
75/80	15	926.7580
75/90	15	926.7590
75/100	15	926.75100
90/110	15	926.90110
110/125	15	926.110125
110/140	15	926.110140
125/150	15	926.125150

### HDPE universal trap, vertical inlet and horizontal outlet

 63	1	931.63
75	1	931.75
90	1	931.90
110	1	931.110

### HDPE trap, vertical inlet and horizontal outlet

 40/40	10	931.4040
40/50	10	931.4050
40/56	10	931.4056
50/50	10	931.5050
50/56	10	931.5056

### HDPE trap - vertical inlet and outlet

 40/40	10	932.4040
0/50	10	932.4050
0/56	10	932.4056
0/50	10	932.5050
0/56	10	932.5056

## Fittings

Size mm	Pack Quantity	Code
<b>HDPE trap - horizontal inlet and outlet</b>		
 40/40	10	945.4040
40/50	10	945.4050
40/56	10	945.4056
50/50	10	945.5050
50/56	10	945.5056

### HDPE washing machine connector

 40	20	933.50
---	----	--------

### HDPE fitting with nut - brass

 40mm/1¼"	40	918.40.125B
50mm/1½"	40	918.40.15B
60mm/1¼"	40	918.40.125EB
60mm/1½"	40	918.50.15B

### HDPE fitting with nut - plastic

 20mm/1¼"	40	918.32.125
30mm/1¼"	40	918.40.125
40mm/1½"	40	918.40.15
50mm/1¼"	40	918.50.125
50mm/1½"	40	918.50.15







### HDPE extended fitting with nut - brass

 40mm/1¼"	20	918.40.125EB
50mm/1½"	20	918.40.15EB
60mm/1¼"	20	918.50.125EB
60mm/1½"	20	918.50.15EB

## Fittings







	Size mm	Pack Quantity	Code
<b>HDPE extended fitting with nut - plastic</b>			
	0mm/1/4"	20	918.40.125E
	0mm/1/2"	20	918.40.15E
	0mm/1/4"	20	918.50.125E
	0mm/1/2"	20	918.50.15E
<b>HDPE bend with nut - *brass •plastic</b>			
	40mm/1/4"*	20	918.40.125.90B
	40mm/1/2"*	20	918.40.15.90B
	40mm/1/4"•	20	918.40.125.90
	40mm/1/2"•	20	918.40.15.90
<b>HDPE reducing bend with nut - *brass •plastic</b>			
	40/50mm/1/4"*	20	918.4050.125.90B
	40/50mm/1/2"*	20	918.4050.15.90B
	40/50mm/1/4"•	20	918.4050.125.90
	40/50mm/1/2"•	20	918.4050.15.90
<b>HDPE end with internal threading, reinforced with steel ring</b>			
	40mm x 1/2"	10	916.40.05
	50mm x 3/4"	10	916.40.075
	60mm x 1"	10	916.40.1
	70mm x 1/2"	10	916.50.05
	80mm x 3/4"	10	916.50.075
	90mm x 1"	10	916.50.1
	100mm x 1 1/4"	10	916.50.125
	110mm x 1 1/2"	10	916.50.15
	120mm x 2"	10	916.56.2
	130mm x 2"	10	916.63.2
	140mm x 2 1/2"	10	916.75.25
<b>HDPE end with external threading, reinforced with steel ring</b>			
	50mm x 1 1/4"	10	917.50.125
	60mm x 1 1/2"	10	917.50.15
	70mm x 2"	10	917.56.2
	80mm x 2"	10	917.63.2
	90mm x 2 1/2"	10	917.75.25
<b>HDPE threaded fitting with brass nipple</b>			
	50mm/1/2" x 15	10	936.40.05N
	60mm/3/4" x 18	10	936.40.075N
	70mm/1/2" x 15	10	936.50.05N
	80mm/3/4" x 18	10	936.50.075N
	90mm/1" x 22	10	936.50.1N

## Fittings





	Size mm	Pack Quantity	Code
<b>HDPE seal for WC sleeves and extended bends</b>			
	115	20	9129.125
<b>HDPE fire stop</b>			
	50	1	9725.50
	56	1	9725.56
	63	1	9725.63
	75	1	9725.75
	90	1	9725.90
	110	1	9725.110
	125	1	9725.125
	160	1	9725.160
	200	1	9725.200
	250	1	9725.250
	315	1	9725.315
<b>HDPE protective cap for socket</b>			
	56	40	9130.56
	63	30	9130.50
	75	30	9130.75
	90	30	9130.63
	110	30	9130.110
	125	20	9130.125
	160	10	9130.160
200	1	9130.200	
<b>HDPE 1 lip seal for sockets</b>			
	100	20	927.100.908
	90	20	927.90.908
	110	20	927.110.908
	125	20	927.125.908
	160	20	927.160.908
	200	20	927.200.908
	250	1	927.250.908
	315	1	927.315.908
<b>HDPE O ring for sockets</b>			
	40	20	9116.40
	50	20	9116.50
	56	20	9116.56
	63	20	9116.63
	75	20	9116.75
	90	20	9116.90
	110	20	9116.110
	125	20	9116.125
160	20	9116.160	
<b>HDPE O ring 100m for adaptors - PVC</b>			
	100	20	9113.908

# HDPE

## Fittings

	Size mm	Pack Quantity	Code
<b>HDPE seal for expansion sockets</b>			
	40	20	911.40.908
	50	20	911.50.908
	56	20	911.56.908
	63	20	911.63.908
	75	20	911.75.908
	90	20	911.90.908
	110	20	911.110.908
	125	20	911.125.908
	160	20	911.160.908
	200	1	911.200.908
<b>HDPE M10 bracket</b>			
	40mm	50	9144.40
<b>Adjustable pipe bracket M10</b>			
	50mm x M10	50	9144.50
	56mm x M10	50	9144.56
	63mm x M10	50	9144.63
	75mm x M10	25	9144.75
	90mm x M10	25	9144.90
	110mm x M10	25	9144.110
	125mm x M10	25	9144.125
	160mm x M10	25	9144.160
<b>Adjustable pipe bracket G1"</b>			
	200mm x 1"	10	9144.200
	250mm x 1"	10	9144.250
	315mm x 1"	10	9144.315
<b>Threaded bar</b>			
	M10 x 1 metre	1	9147
<b>Mounting plate</b>			
	M10	100	9148.10
	G 1/2"	100	9148.19
<b>HDPE rubber flat seal</b>			
	40mm x 1/4"	10	918.40.908
	40mm x 1/2"	10	918.40.918

## Fittings

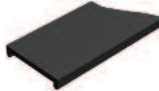
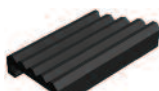
	Size mm	Pack Quantity	Code
<b>Galvanised steel flange 1"</b>			
	G1"	25	9148.25
<b>HDPE M10 anchor bracket</b>			
	40	50	9142.40
	50	50	9142.50
	56	50	9142.56
	63	50	9142.63
	75	25	9142.75
	90	25	9142.90
	110	25	9142.110
	125	25	9142.125
	160	25	9142.160
	<b>HDPE 1/2" bracket</b>		
	40	50	9143.40
	50	50	9143.50
	56	50	9143.56
	63	50	9143.63
	75	25	9143.75
	90	25	9143.90
	110	25	9143.110
	125	25	9143.125
	160	25	9143.160
	<b>HDPE pipe clip</b>		
	40	50	9145.40
	50	50	9145.50
	56	50	9145.56
	63	50	9145.63
	75	25	9145.75
	90	25	9145.90
	110	25	9145.110
	125	25	9145.125
	160	25	9145.160
	<b>Acoustic pipe bracket</b>		
	90	25	9146.90
	110	25	9146.110
	160	25	9146.160
<b>Rubber insert strip</b>			
	40mm x 10m	25	9104.40
	30mm x 50m	25	9104.30
<b>Anti vibration insert</b>			
	30mm x 30 (58mm-314mm)		9105.30

## Electrofusion Coupling



Available in sizes 40 - 315mm

Connection properties:

Non-removable

Tension resistant

### Use

This form of jointing is suitable for on-site welding, additional installations, repair work and modifications.

The pressure required for welding is obtained from the shrinking effect of the sleeve upon

heating and is distributed equally over the entire weld.

This shrinkage has a compensating effect on pipe diameter measurement tolerances.

By removing the central stop ring, the electrical sleeves can be made to slide to enable system modifications and repairs.

The electrical resistance wires will not corrode as they are protected by HDPE after welding.



Pipe scraper



Electrofusion welding machine

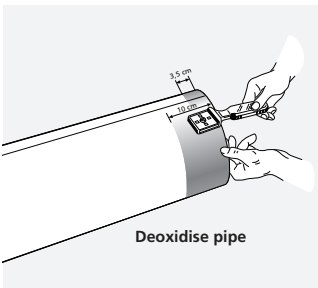

Deoxidise pipe

Cut the pipe squarely, dry, clean and scrape the welding surfaces. The surface must remain clean and dry during the whole welding process, therefore do not touch with your hands.

The length of pipe to be scraped with diameters ranging from 40 - 160mm is 35mm.

The length of pipe to be scraped with diameters 200, 250 and 300mm is 100mm.

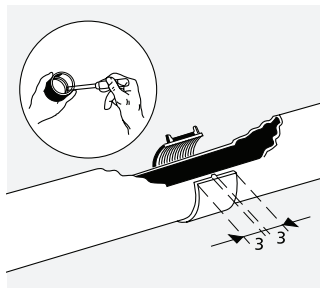

Insert pipe or fitting into sleeve coupling. If the stop ring in the sleeve needs to be removed, mark the depth at 30mm.

## Electrofusion Coupling

Description	Quantity	Product Code
<b>HDPE electrofusion welding machine 40 to 160mm</b>		
40 to 160mm	1	HDN464001
<b>Cable and plugs</b>		
230 Volt	1	HDC464222
<b>Universal electrofusion machine with scraper 40 to 315mm</b>		
230 Volt	1	HDN464333
110 Volt	1	HDN464005
<b>HDPE pipe scraper</b>		
	1	HDC465333
<b>Pipe cutter</b>		
40 to 63mm	1	HDC458001
50 to 140mm	1	HDC458003
<b>Spare blades</b>		
40 to 63mm	1	HDC459001
50 to 140mm	1	HDC459003
<b>HDPE pencils</b>		
	1 (12Pcs.)	HDC474001
<b>HDPE knife</b>		
	1 (12Pcs.)	HDC473001

## Expansion Socket with Ring Seal

Available in sizes 40 - 315mm

Connection properties:

Non-removable

Non-tension resistant

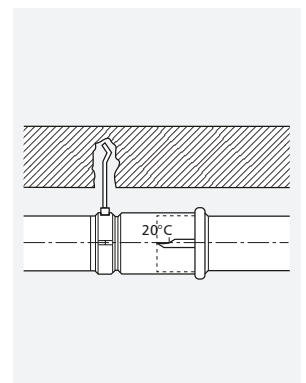
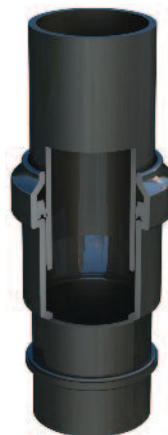

Horizontal assembly (e.g. at an ambient temperature of 20°C).

### Use

Expansion sockets can be used in underground pipe systems as normal push-fit fittings but must be provided on vertical stacks running from floor to floor and for rainwater pipes both inside and outside the building.

# HDPE

## Expansion Socket with Ring Seal

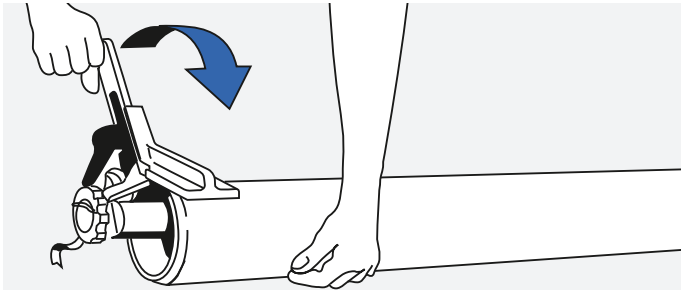

The pipe should be chamfered to approximately 15° and lubricated with suitable Terrain product. Do not use oil or grease which can damage the rubber seal.



Pipe cutter



Bevelling tool

## Butt welding



Suitable for diameters 40 - 315mm

Connection properties:

Non-removable

Tension resistant

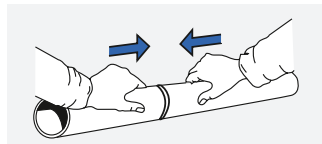
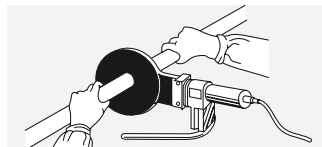

Welding up to Ø63mm

Butt welding can be used in all cases where workshop or on site prefabrication is available.

Butt Welding requires minimal space. This form of jointing is safe, strong, economical and quick.



Machine welding for all diameters

## Expansion Socket with Ring Seal

Description	Quantity	Product Code
<b>Pipe cutter</b>		
40 to 63mm	1	<b>HDC458001</b>
50 to 140mm	1	<b>HDC458003</b>
<b>Spare blades</b>		
40 to 63mm	1	<b>HDC459001</b>
50 to 140mm	1	<b>HDC459003</b>
<b>Bevelling tool</b>		
40 to 250mm	1	<b>HDC460003</b>
<b>Spare blades</b>		
40 to 250mm	1	<b>HDC460111</b>
<b>HDPE pencils</b>		
	1 (12Pcs.)	<b>HDC474001</b>
<b>HDPE knife</b>		
	1 (12Pcs.)	<b>HDC473001</b>
<b>Lubricant</b>		
Please refer to page 19		

## Butt welding

Description	Quantity	Product Code
<b>welding plate with steel box</b>		
40 to 160mm	1	<b>HDC450001</b>
110 to 300mm	1	<b>HDC450003</b>
<b>Portable welding machine Practica 160</b>		
40 to 160mm	1	<b>HDN466003</b>
<b>Spare blade Practica 160</b>		
Practica 160	1	<b>HDN477515</b>
<b>Driving belt</b>		
Practica 160	1	<b>HDN477500</b>
<b>Portable welding machine standard</b>		
40 to 160mm	1	<b>HDN468160</b>
<b>Spare blade</b>		
Standard	1	<b>HDN477515</b>
<b>Driving belt Practica 160</b>		
Standard	1	<b>HDN477500</b>
<b>Portable welding machine super</b>		
75 to 250mm	1	<b>HDN470001</b>
<b>Spare blade</b>		
Super	1	<b>HDN477525</b>
<b>Driving belt</b>		
Super	1	<b>HDN477520</b>
<b>Welding machine Maxi</b>		
90 to 315mm	1	<b>HDN470005</b>
<b>Spare blade</b>		
Maxi	1	<b>HDN477535</b>
<b>Driving belt</b>		
Maxi	1	<b>HDN477540</b>
<b>HDPE knife</b>		
	1 (12Pcs.)	<b>HDC473001</b>

# Plumbing and Drainage Solutions for International Markets



## Polypipe Gulf

Dubai Airport Free Zone (DAFZA)  
Building 4EA  
Office 213  
Dubai  
United Arab Emirates

Tel: +971 46091371  
Fax: +971 46091372

[polypipegulf.fze@polypipe.com](mailto:polypipegulf.fze@polypipe.com)

## Polypipe Terrain

New Hythe Business Park  
College Road  
Aylesford  
Kent  
ME20 7PJ

United Kingdom  
Tel: +44 1622 795200  
Fax: +44 1622 716796

[international@polypipe.com](mailto:international@polypipe.com)  
[www.terraindrainage.com](http://www.terraindrainage.com)

